

# TIAKI Rat & Chinchilla cage

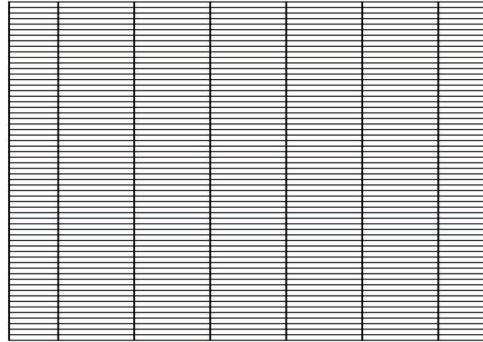

x1



x1



x1

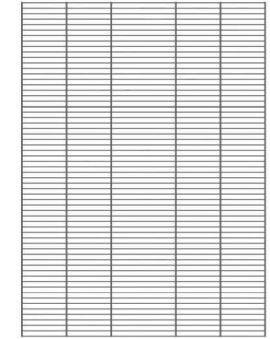

x2



x2

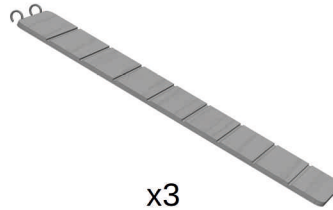

x3

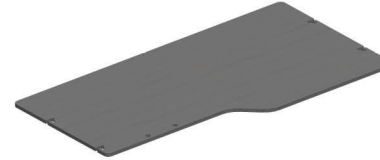

x3



x3



x6 (1x extra)



x2

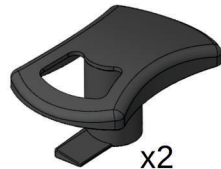

x2

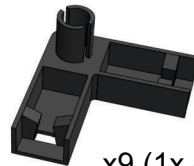

x9 (1x extra)

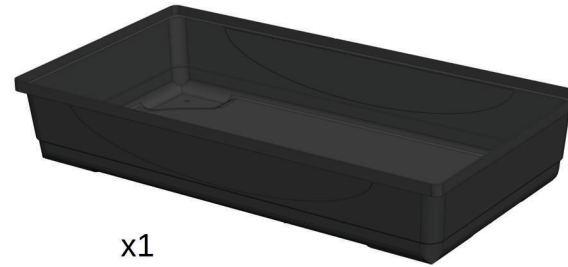

x1



x4



zooplus SE | Sonnenstraße 15 | 80331 München |  
 service@zooplus.com Germany | www.zooplus.com  
 For GB market: zooplus Services Ltd. |  
 30 St. Giles | Oxford | OX1 3LE | England  
 Made in Poland

TIAKI Rat  
 & Chinchilla cage  
 LA 388098



4054651017487

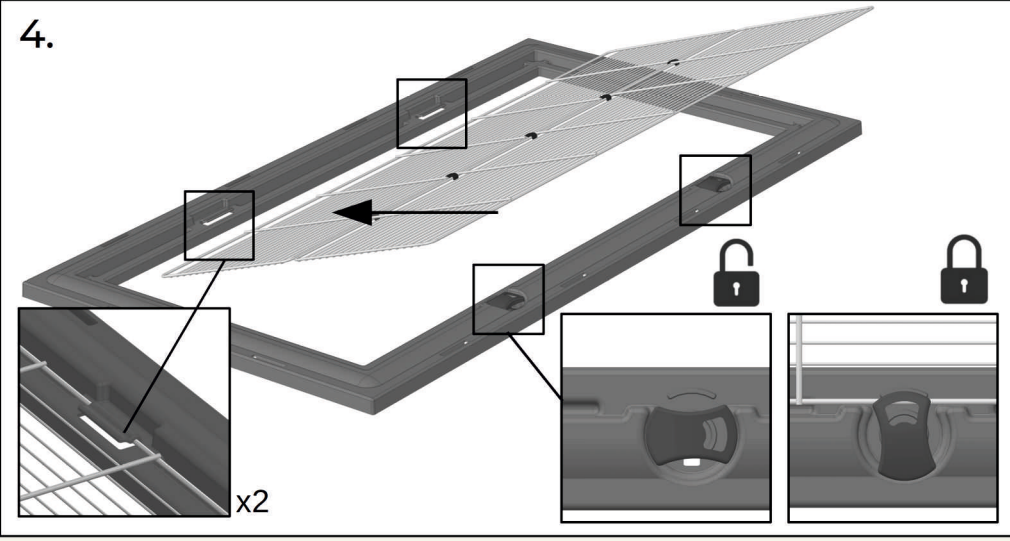
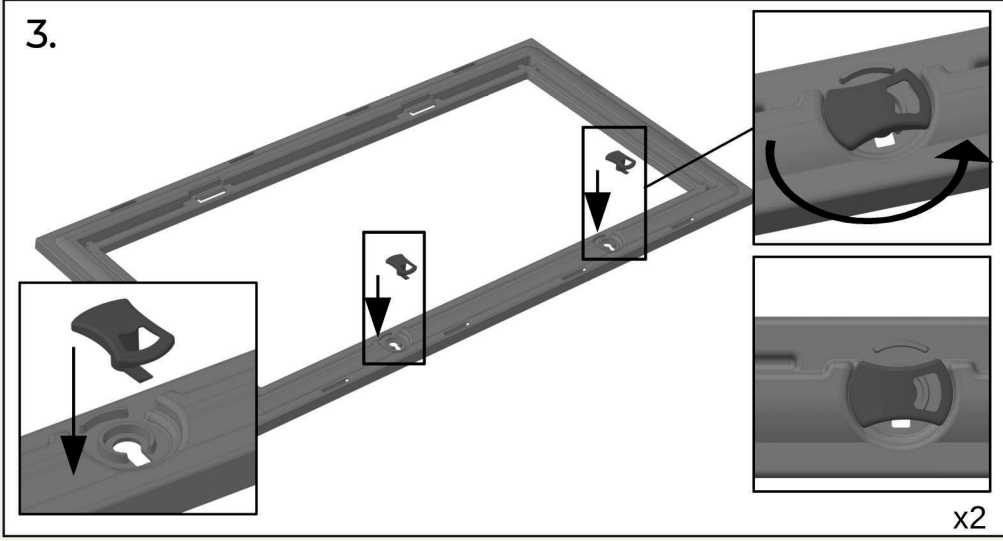
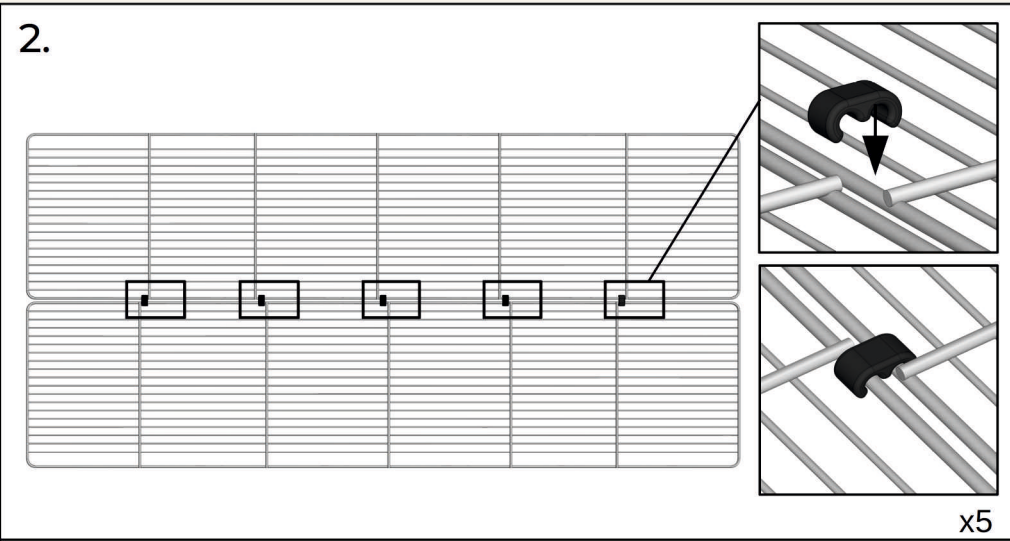
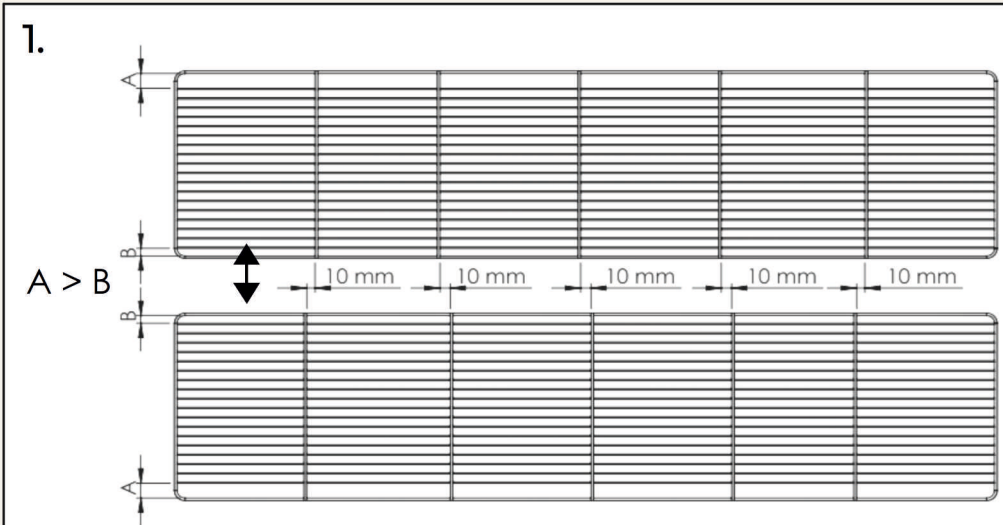

zooplus SE | Sonnenstraße 15 | 80331 München |  
 service@zooplus.com Germany | www.zooplus.com  
 For GB market: zooplus Services Ltd. |  
 30 St. Giles | Oxford | OX1 3LE | England  
 Made in Poland

TIAKI Rat  
 & Chinchilla cage  
 LA 388098

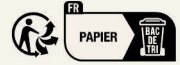

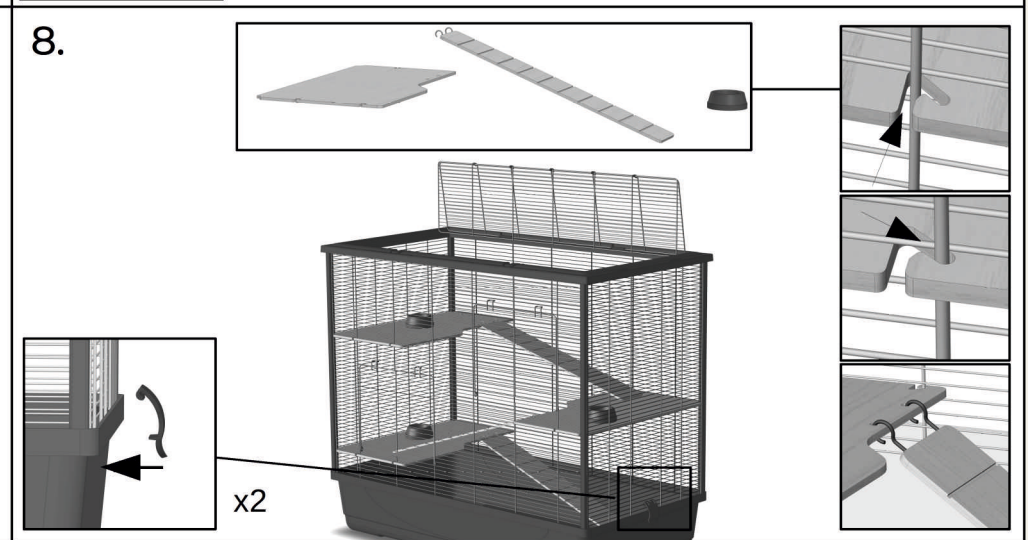
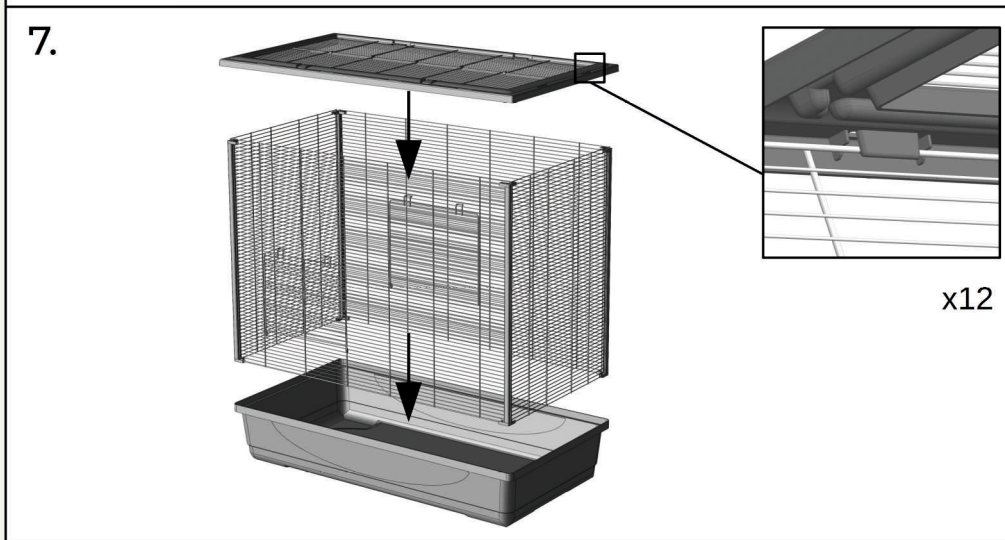
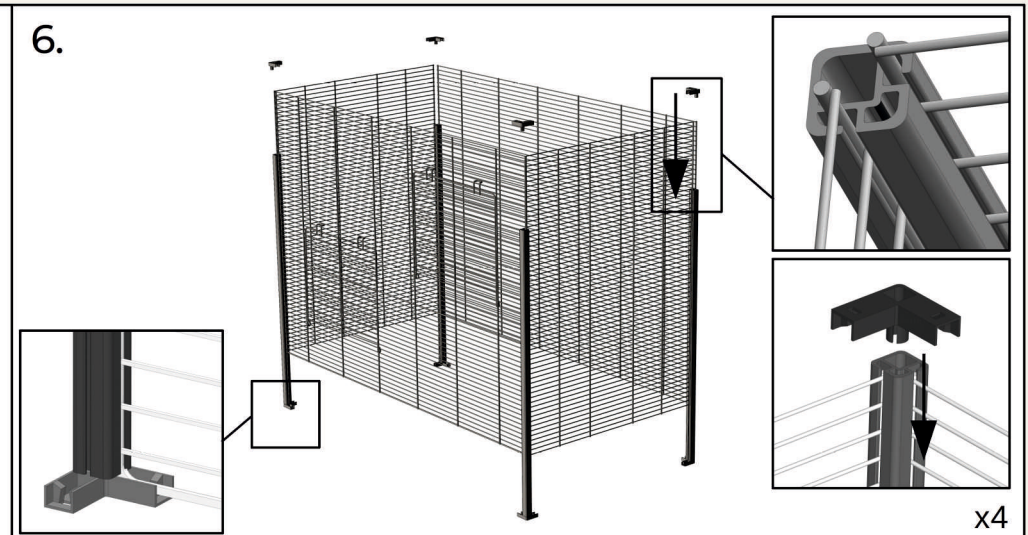
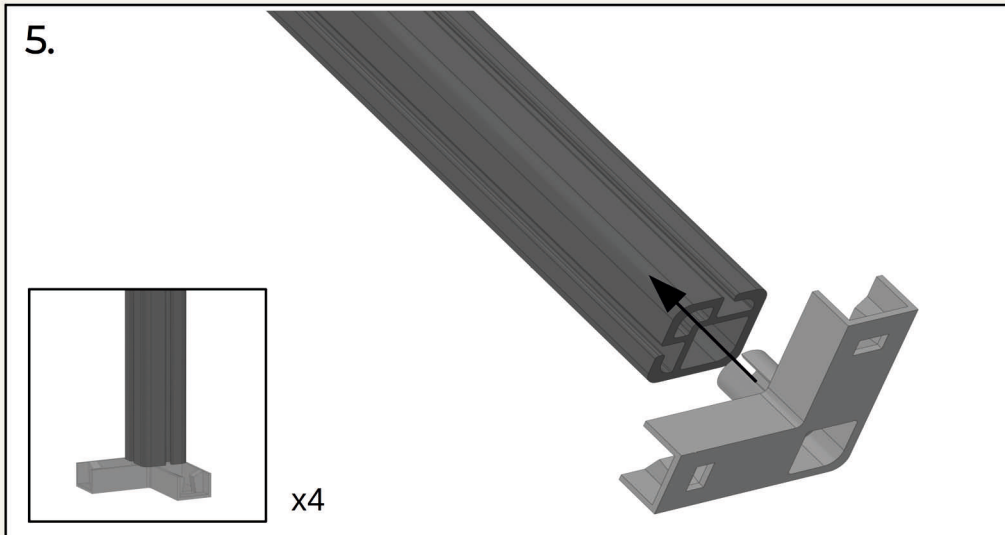

zooplus SE | Sonnenstraße 15 | 80331 München |  
 service@zooplus.com Germany | www.zooplus.com  
 For GB market: zooplus Services Ltd. |  
 30 St. Giles | Oxford | OX1 3LE | England  
 Made in Poland

TIAKI Rat  
 & Chinchilla cage  
 LA 388098

